



ALL
NEW
MAKEUP

ALL
NEW
PACKAGING

에이엔피

경기도 김포시 양촌읍 학운산대로 94
W. anp-pack.com T. 070-4947-8096 F. 031-986-0781
E. anp@anp-pack.com



ANP

ALL
NEW
MAKEUP

ALL
NEW
PACKAGING

에이엔피

(주) ANP는 화장품제조 회사 경력을 바탕으로 2013년 색조화장 용기 제조 회사를 설립하여, 고객에 다가 가고자 노력하고 있습니다. 고객의 취향에 맞는 디자인과 꾸준한 신제품개발, 엄격한 품질관리를 통한 고객만족을 먼저 생각하는 회사입니다.

우수한 개발 이력 및 엄격한 품질 기준 및 안정화된 자동화 양산시스템을 기반으로 개발부터 제품화까지 ONE-STOP 시스템을 가지고 고객이 만족할때까지 최선의 노력을 다 합니다.

(주) ANP는 고객만족 경영, 창조 경영, 열린 경영 이념을 가지고 고객과 약속을 가장 소중히 생각하는 회사이며, 전사원의 단합된 생각과 노력으로 글로벌 경쟁에서 TOP-ONE 을 목표로 성장할 것을 약속드립니다.

eye makeup
lip makeup
face makeup





AB018

Type 삼각 아이브로우 펜슬
Description 삼각 펜슬+브러쉬 / 카트리지 리필 가능
Material 몸체: ABS / 심집(CUP): PBT / 캡: ABS
Catridge 4.1*2.1*30.4
Dimension 139*Ø9.3



AB019

Type 삼각 아이브로우 펜슬
Description 삼각 펜슬+브러쉬 / 카트리지 리필 가능
Material 몸체: ABS / 심집(CUP): PBT / 캡: ABS
Catridge 4.1*2.1*38.1
Dimension 139*Ø9.3



AB021

Type 삼각 아이브로우 펜슬
Description 삼각 펜슬+브러쉬 / 카트리지 리필 가능
Material 몸체: ABS / 심집(CUP): PBT / 캡: ABS
Catridge 4.1*2.1*40.4
Dimension 139*Ø9.3



AB023

Type 원형 아이라이너 펜슬
Description 원형 펜슬+사프너 / Air tight
Material 몸체: ABS / 심집(CUP): PBT / 캡: PP
Catridge Ø3.0*54.0
Dimension 127*Ø9.3(Cap 9.7)



AB024

Type 원형 아이라이너 펜슬
Description 원형 펜슬+사프너 / Air tight
Material 몸체: ABS / 심집(CUP): PBT / 캡: PP
Catridge Ø3.5*51.0
Dimension 127*Ø9.8(Cap 10.2)



AB025

Type 사각 아이브로우 펜슬
Description 사각 펜슬+브러쉬 / 카트리지 리필 가능
Material 몸체: ABS / 심집(CUP): PBT / 캡: ABS
Catridge 3.6*1.8*38.0
Dimension 139*Ø9.3



AB026

Type 타원 아이브로우 펜슬
Description 삼각 펜슬+브러쉬 / 카트리지 리필 가능
Material 몸체: ABS / 심집(CUP): PBT / 캡: ABS
Catridge 4.1*2.1*38.1
Dimension 139*Ø9.3

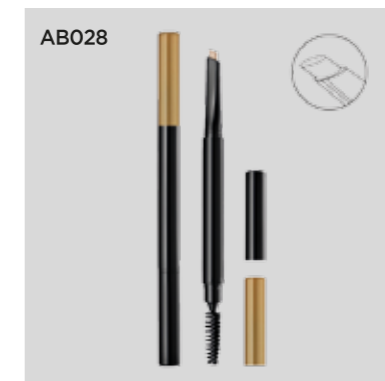

AB028

Type 사각 아이브로우 펜슬
Description 사각 펜슬+브러쉬 / 카트리지 리필 가능
Material 몸체: ABS, PC / 심집(CUP): POM / 캡: ABS
Catridge 3.6*1.8*38.6
Dimension 137*Ø10.0



AB029

Type 아이브로우(라이너) 듀얼
Description Ø3 듀얼 펜슬 / 카트리지 리필 가능 / Air tight
Material 몸체: ABS / 심집(CUP): PBT / 캡: ABS
Catridge Ø3.0*29.6
Dimension 140*Ø9.4



Type 육각 아이브로우 펜슬
Description 육각 펜슬+브러쉬+샤프너+카트리지 타입 (리필 가능)
Material 몸체: ABS / 심집(CUP): POM / 캡: ABS
Catridge 2,25*5,0*37,4
Dimension 147,6*Ø10,3



Type 스키니 아이브로우 펜슬
Description 원형펜슬(슬림형)+브러쉬
Material 몸체: ABS / 심집(CUP): MABS / 캡: ABS
Catridge Ø1,6*38,4
Dimension 148*Ø7,2



Type 슬림 아이브로우 펜슬
Description 원형펜슬(슬림형)+브러쉬 / 원사(MAC, 에스티로더) 전용
Material 몸체: ABS, PP / 심집(CUP): PBT / 캡: ABS
Catridge Ø1,8*38,0
Dimension 134*Ø7,4



Type 물방울 아이브로우, 아이라이너 펜슬
Description 물방울 모양심 / Inner Cap 적용시 Air tight 가능
Material 몸체: ABS/ 심집(CUP): PP/ 캡: PP/ 브러쉬캡: ABS
Catridge 1,75*2,36*41,5
Dimension 148*Ø7,5

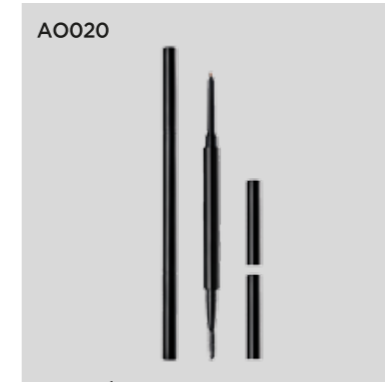

Type 슬림 브로우 펜슬
Description 1,2mm 슬림 브로우 펜슬 + 브러쉬 / Air tight
Material 몸체 : ABS / 심집(CUP) : PP / 펜슬캡 : PP
Catridge 브러쉬캡 : ABS / 심 길이 37mm
Dimension Ø1,2*41,5
Dimension 148*Ø7,0



Type 3in 1 아이브로우 펜슬
Description EYE Brow & 새도우 팁 Ø6,2 펜슬(원형, 삼각)+ 크림&파우더+브러쉬 펜슬부 카트리지타입 (리필 가능)
Material 몸체: ABS/심집(CUP): PBT/철사: AL&PP/TP: NBR/캡: ABS
Catridge 4,1*2,1*30,4
Fill Weight 한계용량 0,4g
Dimension 152,5*Ø9,3



Type 타원 아이브로우 펜슬
Description 타원 펜슬+브러쉬
Material 몸체: ABS / 심집(CUP): PBT / 캡: ABS
Catridge 2,0*1,5*39,4
Dimension 144*Ø7,4



Type 원형 아이브로우 펜슬
Description 원형 펜슬+브러쉬
Material 몸체: ABS / 심집(CUP): PBT / 캡: ABS
Catridge Ø1,8*38,4
Dimension 140*Ø7,4



Type 원형 아이라이너 펜슬
Description Ø3 라인너+샤프너 / Air tight
Material 몸체: ABS / 심집(CUP): POM / 캡: PP
Catridge Ø3,0*44,5
Dimension 129*Ø8,6



Type 삼각 아이브로우 펜슬 & 젤
Description 삼각펜슬+브로우젤(2단) Gel부만 Air tight
Material 몸체: ABS, PP / 심집(CUP): PBT / 캡: ABS
Catridge 4,1*2,1*28,9
Fill Weight 한계용량 2,5ml
Dimension 127*Ø13,4



Type 원형 아이브로우 펜슬 & 파우더
Description Ø3펜슬&파우더&NBR팁 / 펜슬부 카트리지타입 (리필 가능)
Material 몸체: ABS / 심집(CUP): PBT / 캡: ABS, PP
Catridge Ø3,0*30,0
Fill Weight 한계용량 0,4g
Dimension 152,5*Ø9,3



Type 원형 아이브로우 펜슬 & 젤
Description Ø1,8 펜슬 & 젤 브로우, Gel부만 Air tight
Material 몸체 : ABS, PP / 심집(CUP) : PP / 캡 : ABS
Catridge Ø1,8*44,0
Fill Weight 한계용량 2,0ml
Dimension 142*Ø11,5



Type 타원 펜슬+크림(파우더) 듀얼
Description 타원펜슬+파우더 / NBR 팁
Material 몸체: ABS / 심집(CUP): POM / 캡: ABS
Catridge 4,1*2,1*44,5
Fill Weight 한계용량 0,5g
Dimension 151,7*Ø9,6



Type 원형 펜슬+파우더 듀얼
Description Ø3,0 펜슬+파우더 / NBR팁
Material 몸체: ABS / 심집(CUP): POM / 캡: ABS
Catridge Ø3,0*30,9
Fill Weight 한계용량 0,5g
Dimension 134,1*Ø9,7

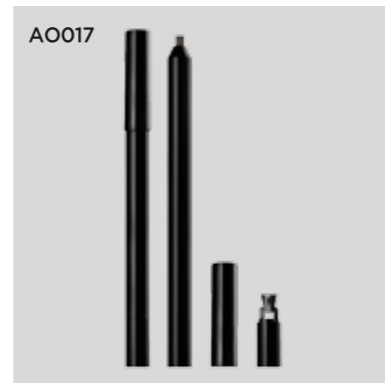

Type 원형 아이라이너 펜슬
Description Ø3,5 펜슬+샤프너 / Air tight
Material 몸체: ABS / 심집(CUP): POM / 캡: PP
Catridge Ø3,5*44,0
Dimension 146,8* Ø8,0 (캡Ø9,4)



Type 원형 아이브로우 펜슬 & 젤
Description Ø1,8 펜슬 & 젤 브로우, Gel부만 Air tight
Material EB024보다 긴 브러쉬
Material 몸체: ABS, PP / 심집(CUP): PP / 캡: ABS
Catridge Ø1,8*44,0
Fill Weight 한계용량 1,8g
Dimension 142*Ø11,5



Type 아이브로우 젤
Description 브로우 젤 + 브러쉬
Material Gel Bottle에 내용물을 보관 (Air tight)
Material 몸체 : ABS / Bottle : PP / 캡 : ABS
Fill Weight 한계용량 1,8g
Dimension 112,2*Ø13,3



Type 액상 아이라이너
Description 액상 아이라이너 (정보 타입) / Air tight
Material 몸체 : PP / 캡 : PP
Catridge Nib:나일론 Ø5*30,0, 돌출전장:8,5mm
Fill Weight 한계용량 3,5ml
Dimension 98*Ø16

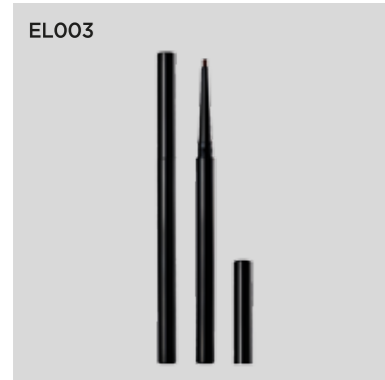

EL003
Type 전진 아이라이너 펜슬
Description 전진 아이라이너 펜슬 / Air tight
Material 몸체: ABS / 심집(CUP): TPE / 캡: ABS
Catridge Ø2,0*37,0
Dimension 124*Ø7,5

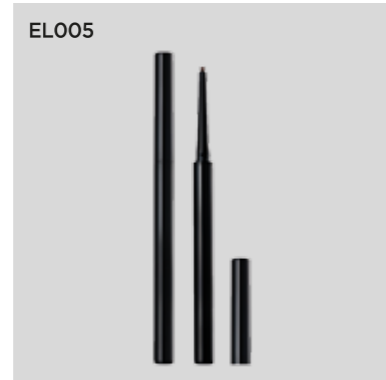

EL005
Type 전진 아이라이너 펜슬
Description 전진 아이라이너 펜슬 / Air tight
Material 몸체: ABS / 심집(CUP): TPE / 캡: ABS
Catridge Ø1,5*33,6
Dimension 114*Ø7,5

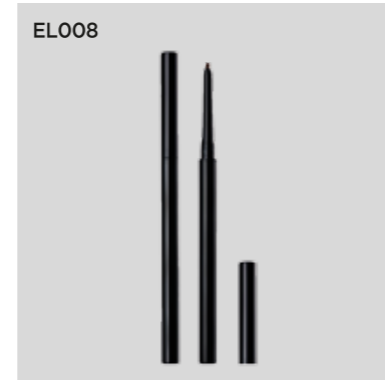

EL008
Type 전, 후진 아이라이너 펜슬
Description 전, 후진 아이라이너 펜슬 / Air tight
Material 몸체: ABS / 심집(CUP): PP / 캡: PP
Catridge Ø1,5*41,5
Dimension 119,9Ø7,0



ES040
Type 원형 아이브로우 펜슬+ NBR tip
Description Ø2 EYE Brow & NBR tip / Air tight
Material 몸체: ABS / 심집(CUP): POM / 캡: PP
Catridge Ø2*36,0 / Tip Size Ø5,0
Dimension 135*Ø9,94



ES041
Type Jar 타입 용기
Description Air tight
Material 몸체: PET-G / 캡: ABS
Fill Weight 한계용량 4g
Dimension 26,6* Ø34

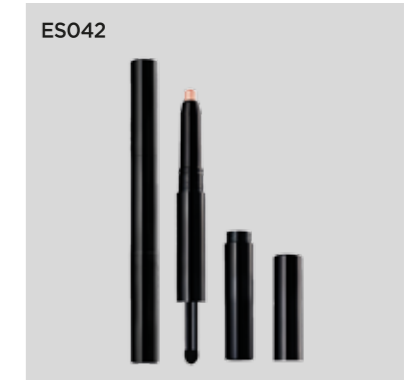

ES042
Type 스틱+크림 & 파우더 섀도우
Description Ø5 에어타이트 스틱 & 섀도우, Pencil부, 섀도우부 Air tight
Material 몸체: ABS / 접시: PP, AL / TIP: NBR / 스틱캡: PP
Catridge Ø5* 36,0
Fill Weight 한계용량 0,7g
Dimension 140,6* Ø13,0



ES034
Type 스틱 & 크림(파우더)
Description Ø5 스틱, NBR Tip & 섀도우만 Air tight
Material 몸체: ABS / 접시: PP, AL / TIP: NBR / 캡: ABS
Catridge Ø2*36,0 / Tip Size Ø6,8 / 6,2
Fill Weight 한계용량 0,7g
Dimension 140,6Ø13,0



ES035
Type 에어타이트 섀도우
Description Ø6,8 Tip 섀도우, Tip 모양 둥근, 뾰족, Air tight
Material 몸체: ABS / 접시: PP, AL / TIP: NBR / 캡: ABS
Catridge Ø2*36,0 Tip Size Ø6,8 / 6,2
Fill Weight 한계용량 0,7g
Dimension 111* Ø13,1



ES036
Type 원형 아이브로우 펜슬+파우더
Description Ø2 EYE Brow & POWDER / Tip 모양 둥근, 뾰족
Material 몸체: ABS / 접시: PP, AL / TIP: NBR / 캡: ABS
Catridge Ø2*36,0 / Tip Size Ø6,8
Fill Weight 한계용량 0,7g
Dimension 141*Ø9,94

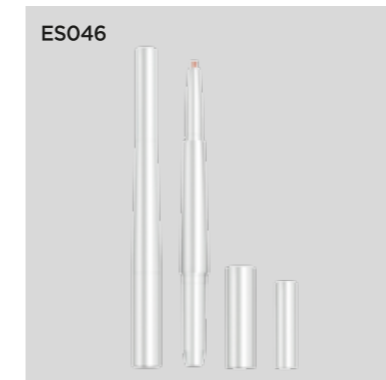

ES046
Type 3파이 & 5파이 스틱
Description 카트리지 타입(리필 가능) Air tight
Material 몸체: ABS / 심집(CUP): POM / 캡: PP
Catridge Ø3*29,6, Ø5*36,0
Dimension 142,5*Ø12,8(Ø9,2)



ES047
Type 크림(파우더) 섀도우
Description Ø10 Tip & 섀도우 / Tip 모양 둥근, 뾰족
Material 몸체: ABS / 접시: AL / TIP: NBR
Catridge Tip Size Ø10
Fill Weight 한계용량 1,2g
Dimension 118*Ø13,4

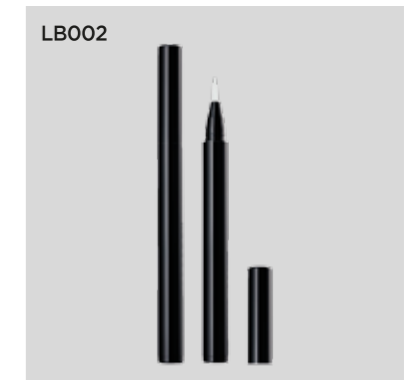

LB002
Type 액상 아이브로우
Description 붓펜(8mm 붓타입) / Air tight
Material 몸체: PP / 브러쉬: PBT / 캡: PP
Fill Weight 한계용량 0,8ml
Dimension 115*Ø9,1

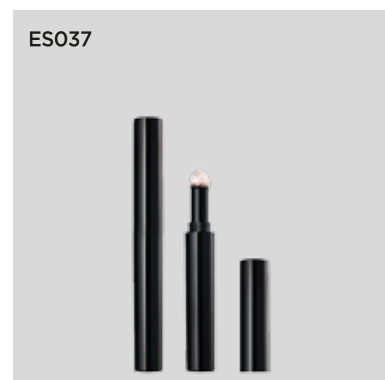

ES037
Type 크림(파우더)
Description Ø10 섀도우
Material 몸체: ABS / 접시: AL / TIP: NBR
Catridge Tip Size Ø10
Fill Weight 한계용량 1,2g
Dimension 120*Ø13,3

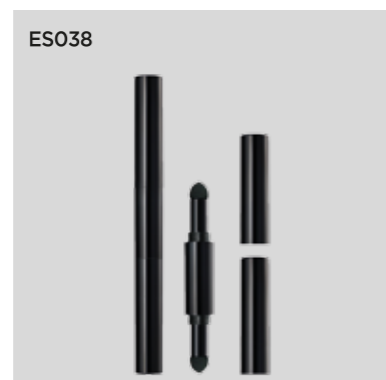

ES038
Type 크림(파우더) 듀얼
Description Ø10 섀도우 듀얼
Material 몸체: ABS / 접시: AL / TIP: NBR
Catridge Tip Size Ø10
Fill Weight 한계용량 1,2g*2
Dimension 141*Ø13,3



ES039
Type 원형 아이브로우 펜슬+ 파우더
Description Ø2 EYE Brow & POWDER / Pencil부 Air tight
Material Tip 모양 둥근, 뾰족
Material 몸체: ABS / 접시: PP, AL / TIP: NBR / 캡: PP
Catridge Ø2*36,0, Tip Size Ø6,8 / 6,2
Fill Weight 한계용량 0,7g
Dimension 141*Ø9,94



LB003
Type 액상 아이브로우
Description 붓펜(7,2mm 닙 타입) / Air tight
Material 몸체: PP / 닙: Nylon / 캡: PP
Fill Weight 한계용량 0,8ml
Dimension 115*Ø9,1



LB004
Type 액상 아이브로우
Description 붓펜(6,3mm 닙 타입 MIN)
Material 몸체: PP / 브러쉬: PBT / 캡: PP
Fill Weight 한계용량 0,5ml
Dimension 93*Ø9,1



LB006
Type 액상 아이브로우
Description 붓펜(폭 3,2mm 삼지창 닙 타입) / Air tight
Material 몸체: PP / 브러쉬: PBT / 캡: PP
Fill Weight 한계용량 0,8ml
Dimension 115*Ø9,1



Type 탱크펜 아이라이너
Description 탱크펜 아이라이너 (8,2mm 붓 타입) / Air tight
Material 몸체 : PP / 브러쉬 : PBT / 캡 : PP
Fill Weight 한계용량 0,8ml
Dimension 120*Ø9,5



Type 탱크펜 아이라이너
Description 탱크펜 아이라이너 7mm 닙 타입 / Air tight
Material 몸체 : PP / 닙 : NYLON / 캡 : PP
Fill Weight 한계용량 0,8ml
Dimension 120*Ø9,5



Type 탱크펜 아이브로우
Description 탱크펜 아이브로우 (8,5mm 붓 타입)
 브러쉬 크기가 라이너 타입보다 큼 / Air tight
Material 몸체 : PP / 브러쉬 : PBT / 캡 : PP
Fill Weight 한계용량 0,8ml
Dimension 120*Ø9,5



Type 붓펜 듀얼 아이라이너
Description Ø3,0 아이라이너 펜슬 & Reservoir 붓 타입 펜
 붓타입, 닙타입 적용 가능 / 펜슬부/ 붓펜 양쪽 Air tight
Material 몸체: PP / 브러쉬: PBT / 심집(CUP): PBT / 캡: PP
Cartridge Ø3,0*30,0
Fill Weight 한계용량 0,8ml
Dimension 155* Ø9,4



Type 붓펜 듀얼 아이라이너
Description Ø3,0 아이라이너 펜슬 & Reservoir 닙 타입 펜
 붓타입, 닙타입 적용 가능 / 펜슬부/ 붓펜 양쪽 Air tight
Material 몸체: PP / 브러쉬: PBT / 심집(CUP): PBT / 캡: PP
Cartridge Ø3,0*30,0
Fill Weight 한계용량 0,8ml
Dimension 155* Ø9,4



Type 붓펜 듀얼 아이라이너
Description Ø3,0 아이라이너 펜슬 & Reservoir 닙 타입 펜
 붓타입, 닙타입 적용 가능 / 펜슬부, 붓펜 양쪽 Air tight
 4발이 심집 적용하여 Soft 내용을 적용 가능
 펜슬부 스펀지 적용하여 심박짐 방지 적용
Material 몸체: PP / 브러쉬: PBT / 심집(CUP): PBT / 캡: PP
Cartridge Ø3,0*30,0
Fill Weight 한계용량 0,8ml
Dimension 155* Ø9,4



Type 탱크펜 아이라이너 듀얼 펜슬
Description 2파 Ø2 전후진 펜슬+탱크펜 아이라이너 8,2mm
 붓타입(미니) 카트리리지 타입 / Air tight
Material 몸체: ABS / 브러쉬: PBT / 심집(CUP): PP / 캡: PP
Cartridge Ø2*41,0
Fill Weight 한계용량 0,3ml
Dimension 152,8*Ø9,5



Type 탱크펜 아이라이너 듀얼 펜슬
Description 1,6파 Ø1,6 전후진 펜슬+탱크펜 아이라이너 8,2mm
 붓타입(미니) 카트리리지 타입 / Air tight
Material 몸체: ABS / 브러쉬: PBT / 심집(CUP): PP / 캡: PP
Cartridge Ø1,6*41,0
Fill Weight 한계용량 0,3ml
Dimension 152,8*Ø9,5



Type 붓펜 듀얼 아이브로우
Description Ø3,0 아이브로우 펜슬 & Reservoir 붓 타입 펜
 붓타입, 닙타입 적용 가능, 붓펜 쪽만 Air tight
Material 몸체: PP / 브러쉬: PBT / 심집(CUP): PBT / 캡: PP, ABS
Cartridge Ø3,0*30,0
Fill Weight 한계용량 0,8ml
Dimension 155* Ø9,4



Type 스틱 & Tip
Description Ø7,3 스틱 & Ø10 Tip / Air tight
Material 몸체 : ABS / 심집(CUP) : PP / 캡 : PP
Cartridge Ø7,3*37,9
Dimension 126,4*Ø13



Type 스틱 & 파우더 듀얼
Description Ø7,3 스틱 & 파우더
Material 몸체 : ABS / 심집(CUP) : PBT / 캡 : ABS
Cartridge Ø7,3*36,0 / Tip Size Ø10
Dimension 147,9*Ø13,3



Type 스틱 & 브러쉬
Description 7,3파이 스틱 & 브러쉬 / Air tight
Material 몸체 : ABS / 심집(CUP) : PP / 캡 : PP
Cartridge Ø7,3*36,0
Dimension 126,4*Ø13



Type 붓펜 듀얼 아이브로우
Description 삼각 아이브로우 펜슬 & Reservoir 붓 타입 펜
 붓타입, 닙타입 적용 가능 / 붓펜 쪽만 Air tight
Material 몸체: PP / 브러쉬: PBT / 심집(CUP): PBT / 캡: PP, ABS
Cartridge 4,1*2,1*30,4
Fill Weight 한계용량 0,8ml
Dimension 155* Ø9,4



Type 붓펜 듀얼 아이브로우
Description Ø3,0 아이브로우 펜슬 & Reservoir 닙 타입 펜
 붓타입, 닙타입 적용 가능, 붓펜 쪽만 Air tight
Material 몸체: PP / 브러쉬: PBT / 심집(CUP): PBT / 캡: PP, ABS
Cartridge Ø3,0*30,0
Fill Weight 한계용량 0,8ml
Dimension 155* Ø9,4



Type 붓펜 듀얼 아이브로우
Description 삼각 아이브로우 펜슬 & Reservoir 닙 타입 펜
 붓타입, 닙타입 적용 가능 / 붓펜 쪽만 Air tight
Material 몸체: PP / 브러쉬: PBT / 심집(CUP): PBT / 캡: PP, ABS
Cartridge 4,1*2,1*30,4
Fill Weight 한계용량 0,8ml
Dimension 155* Ø9,4



Type 스틱+칫솔브러쉬
Description Ø7,3 스틱 + 칫솔타입 브러쉬 / Air tight
Material 몸체 : ABS / 심집(CUP) : PP / 캡 : PP
Cartridge Ø7,3*36,0
Dimension 126,1*Ø13,0



Type 브로우 마스크라
Description Air tight / 브러쉬 모양 변경 가능
Material 커버 : ABS / 바디 : PP
Fill Weight 한계 용량 1,2g
Dimension 107,5*Ø12,6

lip makeup

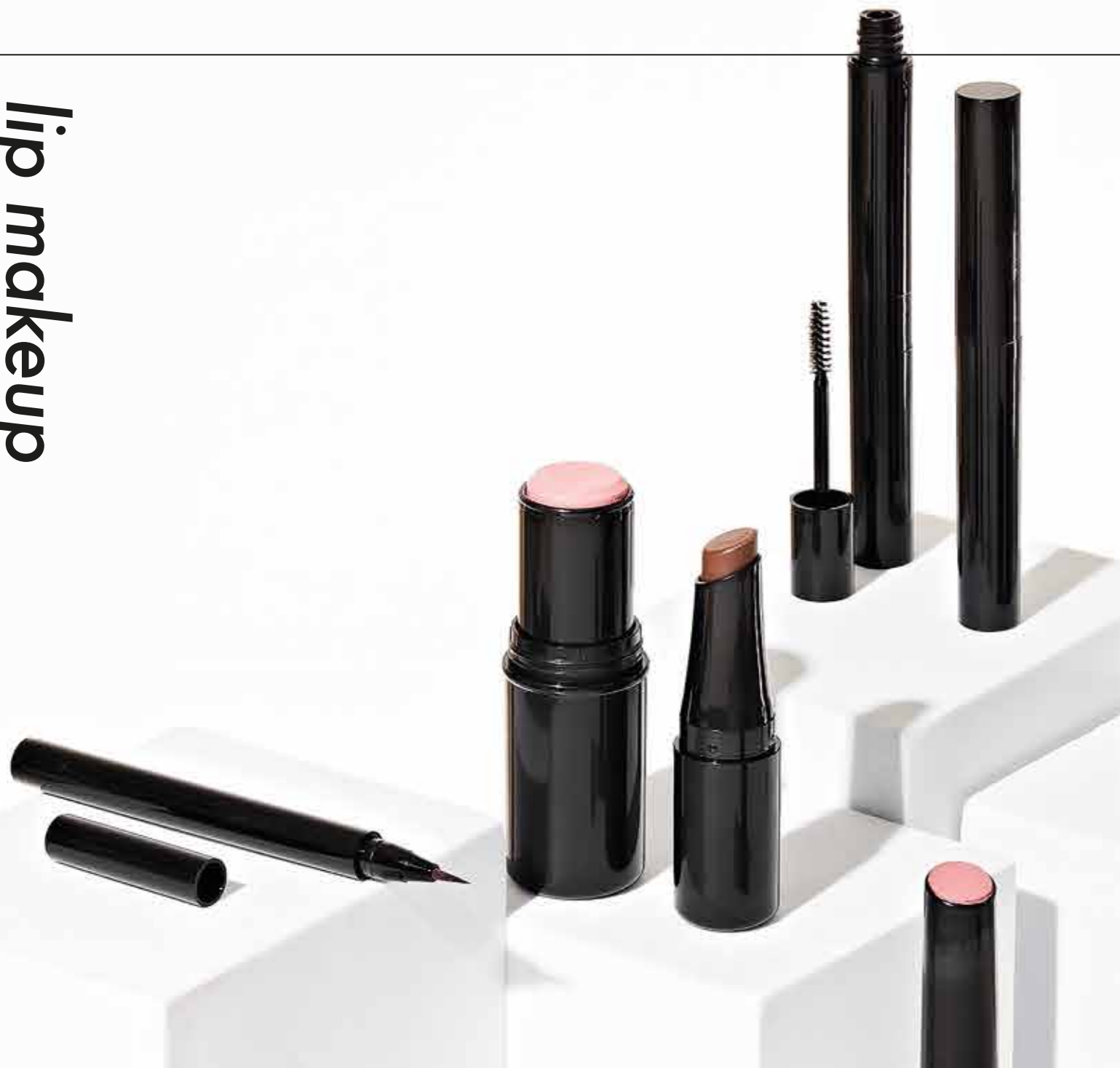

새로운 사용성의 립 메이크업 패키징, 에이엔피에서 만나보세요!



LT057
Type 원형 레귤러 립스틱
Description Ø12 원형 레귤러 립스틱 / 충전권: 금속, 사출 가능
Material 몸체: PET-G / 심집(CUP): PP / 캡: PET-G
Catridge Ø12*40.0
Dimension 126.4*Ø20.5



LT058
Type 에어타이트 스틱
Description Ø5 원형 스틱 / Air tight
Material 몸체: ABS / 심집(CUP): POM / 캡: PP
Catridge Ø5*36.0
Dimension 91.9*Ø13



LT059
Type 싱글 스틱
Description Ø8 스틱
Material 몸체: ABS / 심집(CUP): POM / 캡: ABS
Catridge 심집 내경 Ø7.2* 카트리지 내경 Ø8.2 * 37.3
Dimension 90.0*Ø13.2



LT060
Type 립카드
Description 8종의 색조 내용을 담을수 있는 Sample 제안 용기
Material 몸체: ABS / 캡: PET-G
Catridge Ø12* 2/ 8 Hole
Dimension 80*50*4.5



LT073
Type 전진 립스틱
Description 후진 안되는 전진 립스틱으로 한바퀴에 0.1mm 나옴
Soft 내용물 적용 가능 / 용기 전장을 줄인 LT060 미니 버전
Material 몸체: ABS / 심집(CUP): PE / 캡: ABS
Catridge Ø11*17.4
Dimension 62.0*Ø17.5



LT074
Type 슬림립스틱
Description 몸체 사각 / 내측 원형 Ø8.9 스틱
Material 몸체: ABS / 심집(CUP): PP / 캡: ABS
Catridge 심집 내경 Ø8.1* 카트리지 내경 Ø8.9 * 37.7
Dimension 98.3*Ø13.8



LT050
Type 전진립스틱
Description 후진 안되는 전진 립스틱으로 한바퀴에 0.1mm 나옴
Soft 내용물 적용 가능
Material 몸체: ABS / 심집(CUP): PE / 캡: ABS
Catridge Ø11* 31.4
Dimension 81* Ø17.5



LT051
Type 슬림 전진립스틱
Description 후진 안되는 전진 립스틱으로 한바퀴에 0.1mm 나옴
Top (캡 위 마개) 적용하여 외곽에서 내용물 색상 확인 가능
Material 몸체: ABS / 심집(CUP): PE / 캡: ABS
Catridge Ø7.5* 47.3
Dimension 119.0*Ø13.1



LT052
Type 슬림 전진립스틱
Description 후진 안되는 전진 립스틱으로 한바퀴에 0.1mm 나옴
전진 립스틱 (TOP X)
Material 몸체: ABS / 심집(CUP): PE / 캡: ABS
Catridge Ø7.5* 47.3
Dimension 109.0*Ø13.1



TL001
Type 립 마커
Description Air tight
Material 몸체: PP / NB: / 캡: PP
Catridge 넵 Ø5*8.5돌출
Fill Weight 한계 용량 3g
Dimension 98.0* Ø16.0



TL002
Type 원형 립글로스
Description Tip 모양 변경 가능 / Air tight
Material 몸체: PET-G / Tip: / 캡: ABS
Catridge Tip: Elastomer / Nylon
Fill Weight 한계 용량 6g
Dimension 89.74*Ø20.5

face makeup



다양한 페이스 메이크업 에이전피에서 만나보세요!



PS003

Type 릴리즈 에어타이트 파운데이션
Description 15ml 릴리즈 에어타이트 파운데이션
 전진만 가능 / Air tight
Material 몸체: PP, ABS / 심집(CUP): PE / 캡: PP
Fill Weight 한계용량 15ml
Dimension 115*Ø30



PS005

Type 스틱 파운데이션
Description Ø18 원형 스틱 / Air tight
Material 몸체: ABS / 심집(CUP): POM / 캡: ABS
Cartridge 심집 내경 Ø18* 카트리지 내경 Ø19.2 * 36.0
Dimension 85.9*Ø27



PS006

Type 릴리즈 에어타이트 파운데이션
Description 9ml 릴리즈- 9ml 릴리즈 에어타이트 파운데이션
 전진만 가능 / Air tight
Material 몸체: PP / 심집(CUP): PE / 캡: PP
Fill Weight 한계 용량 : 9ml
Dimension 105.5*Ø24



PS007

Type 릴리즈 에어타이트 파운데이션
Description 5ml 릴리즈 에어타이트 파운데이션
 전진만 가능 / Air tight
Material 몸체: PP / 심집(CUP): PE / 캡: PP
Fill Weight 한계 용량 : 5ml
Dimension 117*Ø17



ST001

Type 스틱 파운데이션
Description Ø18 원형 스틱
Material 몸체: ABS / 심집(CUP): POM / 캡: ABS
Cartridge 심집 내경 Ø18* 카트리지 내경 Ø19.2 * 36.0
Dimension 85.9*Ø27.7



ST002

Type 스틱 파운데이션+브러쉬
Description Ø18 원형 스틱+브러쉬
Material 몸체 : ABS / 심집(CUP) : POM / 캡 : ABS
Cartridge 심집 내경 Ø18* 카트리지 내경 Ø19.2 * 36.0
Dimension 114.9*Ø27.7



ST003

Type 썬스틱
Description 타원 썬 스틱
Material 몸체: PP / 심집(CUP): POM / 캡: ABS
Cartridge 18*35.5*36.2
Dimension 23.6*41.1*83.0



ST004

Type 스틱(싱글)
Description Ø13.5 싱글 스틱
Material 몸체 : ABS / 심집(CUP) : POM / 캡 : ABS
Cartridge 심집 내경 Ø13.5* 카트리지 내경 Ø14.4 * 29.2
Dimension 77.0*Ø19.9

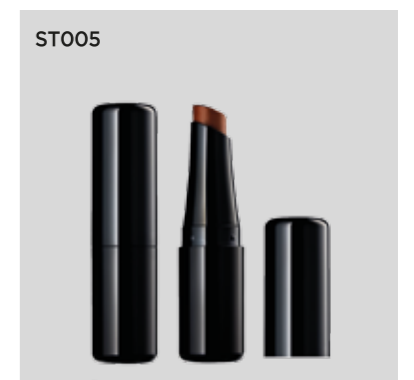

ST005

Type 스틱(싱글)
Description Ø9.1 싱글 스틱
Material 심집 내경 Ø9.1* 카트리지 내경 Ø10.2 * 28.2
Cartridge 몸체 : ABS / 심집(CUP) : POM / 캡 : ABS
Dimension 77.0*Ø19.9



ST006

Type 스틱(듀얼)
Description Ø9,1, Ø13,5 듀얼 스틱
Material 몸체 : ABS / 심집(CUP) : POM / 캡 : ABS
Catridge 심집 내경 Ø13,5* 카트리지가 내경 Ø14,4 * 29,2
 심집 내경 Ø9,1* 카트리지가 내경 Ø10,2 * 28,2
Dimension 128,0*Ø19,9



ST007

Type 스틱 파운데이션+브러쉬
Description Ø18 원형 스틱+브러쉬
Material 몸체 : ABS / 심집(CUP) : POM / 캡 : ABS
Catridge 심집 내경 Ø18* 카트리지가 내경 Ø19,2 * 36,0
Dimension 114,9*Ø27,7



ST008

Type 스틱
Description Ø11 스틱
Material 몸체 : ABS / 심집(CUP) : POM / 캡 : ABS
Catridge 심집 내경 Ø9,1* 카트리지가 내경 Ø11 * 36,4
Dimension 109,0*Ø17,74



ST009

Type 스틱
Description Ø7,8 스틱
Material 몸체 : ABS / 심집(CUP) : POM / 캡 : ABS
Catridge 심집 내경 Ø6,8* 카트리지가 내경 Ø7,8 * 34,4
Dimension 112* Ø11,8(Ø13,7)



ST010

Type 스틱 & Tip
Description Ø11 스틱 & Ø10 NBR Tip
Material 몸체 : ABS / 심집(CUP) : POM / Tip : NBR / 캡 : ABS
Catridge 심집 내경 Ø9,1* 카트리지가 내경 Ø11 * 36,4
Dimension 124,1*Ø16,1(Ø17,6)



ESO48

Type Ø22 파우더(헤어)
Description Ø22 Tip / 크림(파우더)
Material 몸체: ABS / 접사: AL
Catridge Tip Size Ø22
Dimension 78*Ø25